



ENDORSED CONGRESS



The International Federation for
the Surgery of Obesity and
Metabolic Disorders (IFSO)

ESBS

**19th ANNUAL CONFERENCE OF
THE EGYPTIAN SOCIETY FOR
BARIATRIC SURGERY**

 **OCTOBER 26-28, 2023**

 **DUSIT THANI LAKE VIEW CAIRO EGYPT**

A MEMBER SOCIETY OF IFSO

IN COLLABORATION WITH PAN ARAB SOCIETY FOR METABOLIC AND
BARIATRIC SURGERY (PASMBS)

AND IFSO MIDDLE EAST & NORTH AFRICA CHAPTER (MENAC)

PROGRAM

Congress President
Prof. Dr. Khaled Gawdat

Vice Chairman
Prof. Dr. Essam Abdel Gilil



Accredited by
The AACME

www.esbs-eg.com

ESBS President
Prof. Dr. Alaa Abass

Secretary General
Prof. Dr. Mohey Elbanna

**Auxiliary grasping
force of reload surface**

Avoid the tissue slipping out during firing



Tri-Staple technology



**Real
one-handed operation**

Easy and convenient to open
and close the jaw by one-handed operation



**Safety
block mechanism**

Ensure the knife can be returned to the
original position anytime in case of emergency

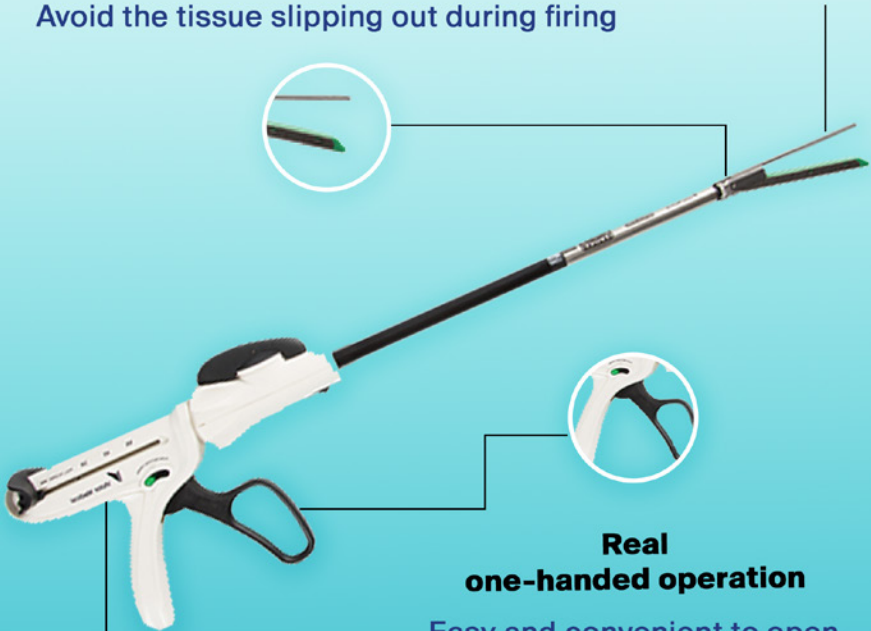



PULL GREEN TRIGGER
BEFORE FIRE

EZISURG MEDICAL

EASYENDO™ SERIES LITE



Special Cartridge design
for surgical needs

8.5mm

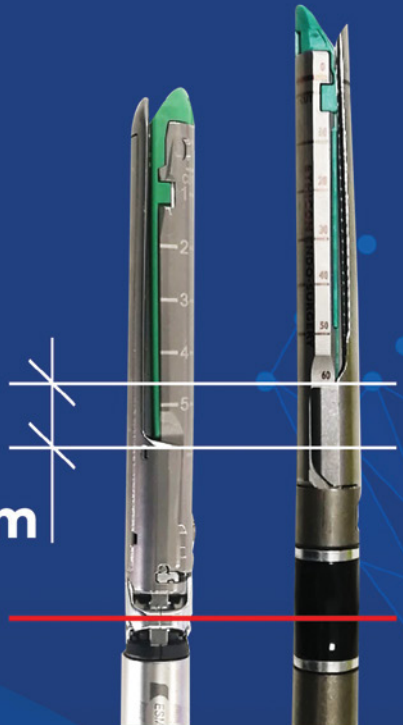

Arabian Co
medical equipment

WELCOME MESSAGE FROM THE CONGRESS PRESIDENT:

It is my proud privilege and honor to invite you to the 19th Annual Congress of The Egyptian Society for Bariatric Surgery to be held in Cairo, Egypt on the 26-28 October, 2023.

The Egyptian Society for Bariatric Surgery (ESBS) was founded as a member Society of the International Federation for the Surgery of Obesity and Metabolic disorders (IFSO) in 1999. Bariatric surgery has enjoyed exponential growth in Egypt. The 19th Annual Congress of the ESBS comes as a landmark meeting. The meeting has an international panel of experts, world-class Middle East and Egyptian bariatric surgery experts and great original studies from Egypt to make the conference a true scientific gathering.

The ESBS 2023 congress is a comprehensive, multi-disciplinary forum where leading national and international experts will conduct a critical review. The Congress shall provide a platform to address and debate on the recent advances and challenges in the field of Metabolic and Bariatric surgery.

Egypt has a rich historic culture and hosts world famous tourists attraction sites. Join us at our conference and enjoy the rich deep culture of Egypt.

PROFESSOR DR KHALED GAWDAT

President Of IFSO MENA Chapter
Congress President
Founder and Honorary president of the ESBS



WELCOME MESSAGE FROM THE ESBS PRESIDENT AND CONGRESS SECRETARY GENERAL:

Dear colleagues,

It is my pleasure to join the entire ESBS executive council along with the president of ESBS Prof. Dr. Alaa Abbass in welcoming you to our 19th Annual congress in Cairo.

This year program is committed to provide tools for bariatric professionals, whether established surgeons or those new to the field, to improve the quality of their practices.

This year program contains two preconference courses to be held on 26-28 October, 2023. The scientific sessions will cover two and half days with a full track dedicated to integrated health professionals, abstract sessions and video sessions.

I look forward to seeing each of you here as we host our 19th Annual Congress of ESBS

PROF. DR. MOHEY ELBANNA
Conference Secretary General

PROF. DR. ALAA ABBASS SABRY
ESBS President

COMMITTEES:

ESBS EXECUTIVE BOARD:

President:

Prof. Dr. Alaa Abbass

Past President:

Prof. Dr. Essam AbdelGilil

COUNCIL MEMBERS:

Pro. Dr. Hany Nawara
Pro. Dr. Mohey Elbanna
Prof. Dr. Osama Fouad

Prof. Dr. Tarek Youssef
Prof. Dr. Ali Elanwar

FOUNDER AND HONORARY PRESIDENT AND IFSO REPRESENTATIVE:

Prof. Dr. Khaled Gawdat

ORGANIZING COMMITTEE:

Prof. Dr. Essam AbdelGilil
Prof. Dr. Khaled Gawdat
Prof. Dr. Saeed AlKayyal
Prof. Dr. Ahmed Ibrahim
Prof. Dr. Osama Taha

Prof. Dr. Mohey Elbanna
Prof. Dr. Mohamed Abu Zeid
Prof. Dr. Ahmed Osman
Prof. Dr. Tarek Youssef
Prof. Dr. Ali Elanwar

SCIENTIFIC COMMITTEE:

Prof. Dr. Saeed AlKayaal (Chairman)
Prof. Dr. Osama Taha
Prof. Dr. Mohey Elbanna
Prof. Dr. Khaled Gawdat

Prof. Dr. Osama Fouad
Prof. Dr. Mohamed Abu Zeid
Prof. Dr. Ahmed Osman

President of the Congress:

Prof. Dr. Khaled Gawdat

Secretary General of the Congress:

Prof. Dr. Mohey Elbanna

A transformative approach
to weight loss and health



INTERNATIONAL SPEAKERS:



Aayed Qahtani



Abdelrahman Salem



ABDULELLAH NIYAZ



Ahmad Bashir



ALEKSANDR NEIMARK



Ali Alhamadani



INTERNATIONAL SPEAKERS:



Ali Khammas



Badar Alhadrami



Esam Batayyah



Hend AlMajrafi



Moataz Basha



Mohamed AlJarallah

INTERNATIONAL SPEAKERS:



Mohammed Hadad



Mounir Ben Chatouh



Mourad Niazi



Mustafa Ghura



Osama Alsanie



Saeed Ali Alsareii



INTERNATIONAL SPEAKERS:



Sherif Hakky



Tamer Osman



TOGHRUL TALISHINSKIY



Medhat Shalaby

REUSABLE, SMART, AND PRECISE STAPLING WITH ONE HAND

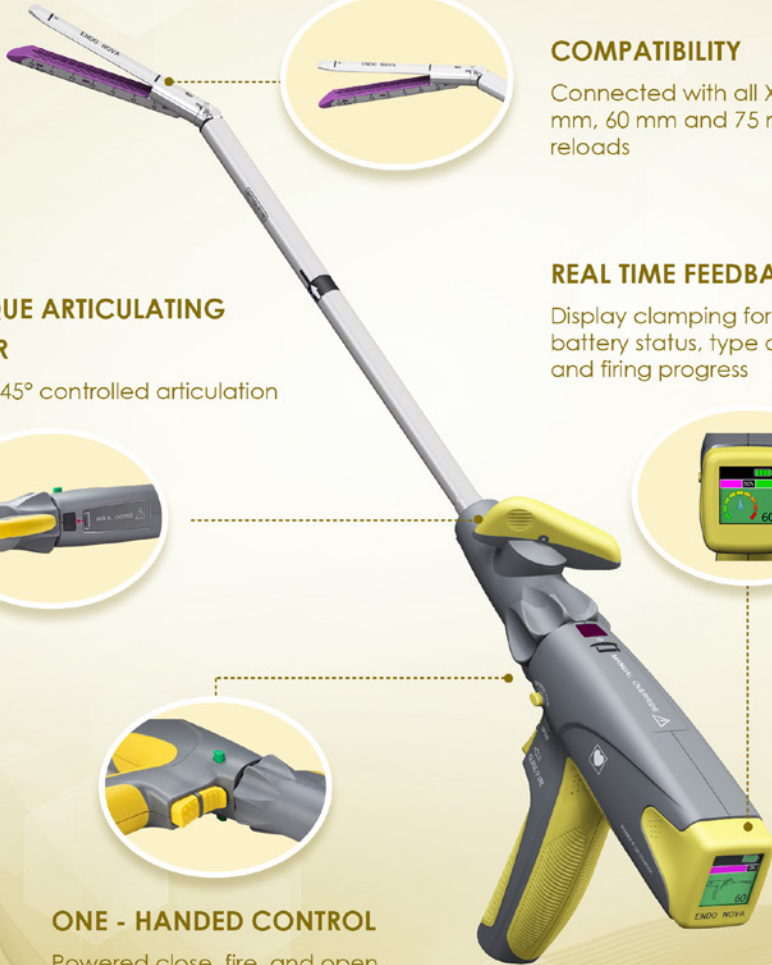

COMPATIBILITY

Connected with all XNY 45 mm, 60 mm and 75 mm reloads

REAL TIME FEEDBACK

Display clamping force, battery status, type of reload and firing progress

UNIQUE ARTICULATING LEVER

Up to 45° controlled articulation

ONE - HANDED CONTROL

Powered close, fire, and open with ease and no shaking

Vitamins You Should Take After Sleeve Gastrectomy



Pure Whey Protein

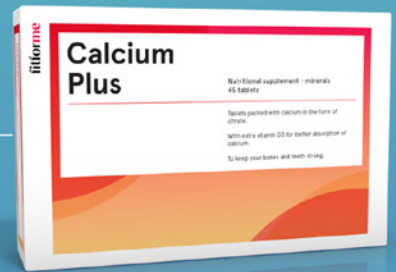

Calcium Plus



Ferro Forte & WLS Forte

Ferro Optimum
& WLS Optimum



SWEET & TANGY

KEEP FROZEN



Naturally
Vegan



Rich in Anthocyanins
& Polyphenols



Naturally
Gluten Free



RICH IN
VITAMIN C

SOURCE OF
POTASSIUM,
VITAMIN A

AND
FIBRE

SUPER BERRY THAT PACKS A POWERFUL PUNCH

Antioxidant Power House



100%
Grown in Canada

150g

SWEET & TANGY

KEEP FROZEN

Power-packed with Vitamins, Minerals, Antioxidants, Anthocyanins and more, Haskap berries deliver top-shelf nutritional benefits.

Compare other berries, compare other fruits. See for yourself all the nutritional goodness this amazing berry has to offer.



Blend in your Smoothie



Add to your Oatmeal



Mix in your yogurt

	Haskap	Blurberry	Acai Puree	Apple
Vitamin C	56%	16%	0%	7%
Vitamin A	20%	0%	3%	0%
Potassium	7%	2%	3%	3%
Calcium	6%	1%	3%	1%
Iron	6%	2%	0%	1%
Copper	19%	9%	0%	4%

Eat Haskap, Live Well

With a rich history that was first officially documented in 1755, the Haskap Health Movement has migrated from northeastern Asia across the world to find a home here in Nova Scotia, where these hardy and healthy berries are grown naturally, picked fresh and quickly frozen.

The Haskap berry's unique oval-rectangular shape results from each whole berry actually consisting of twin berries wrapped in an outer purple-blue skin. This two-for-one berry also has a remarkable flavour profile. Imagine a mash-up of grape, raspberry, blueberry and black currant topped with a zingy finish. Every Haskap berry tells its own story!



Haskap Superfood Smoothie

- 1/2 cup "Nova Scotia's Own Haskap Berries"
- 1/2 cup liquid of choice (water or plant based milk)
- 1 spoonful of honey
- Optional: 1/2 Frozen or Fresh Banana
- Add all ingredients to a blender, mix & enjoy!

Nutrition Facts

Per 1 cup (140g)

Calories 80

% Daily Value*

Fat **0.4g** 1%
Saturated **0.1g** 1%
+ Trans **0g**

Carbohydrates **20g**
Fibre **4g** 14%
Sugars **11g** 11%

Protein **1g**
Cholesterol **0mg**
Sodium **0mg** 0%

Vitamin A **182ug** 20%

Vitamin C **50mg** 56%

Potassium **308mg** 7%

Calcium **57mg** 6%

Iron **1mg** 6%

Magnesium **34mg** 8%

Zinc **0.42mg** 4%

Copper **0.17mg** 19%

Manganese **0.22mg** 10%

*5% or less is a little, 15% or more is a lot

Ingredients: Haskap Berries

PREPARED FOR

North 45 Orchards

1496 Bedford Highway, Bedford,
Nova Scotia, Canada B4B 1E5



100%
Grown in Canada



Naturally
Vegan



Rich in Anthocyanins
& Polyphenols



Naturally
Gluten Free

150g

TOUCHSTONE®

Leading through Innovation

TST

Mega-Windows

Tailored Treatment
for Hemorrhoids
and Prolapse

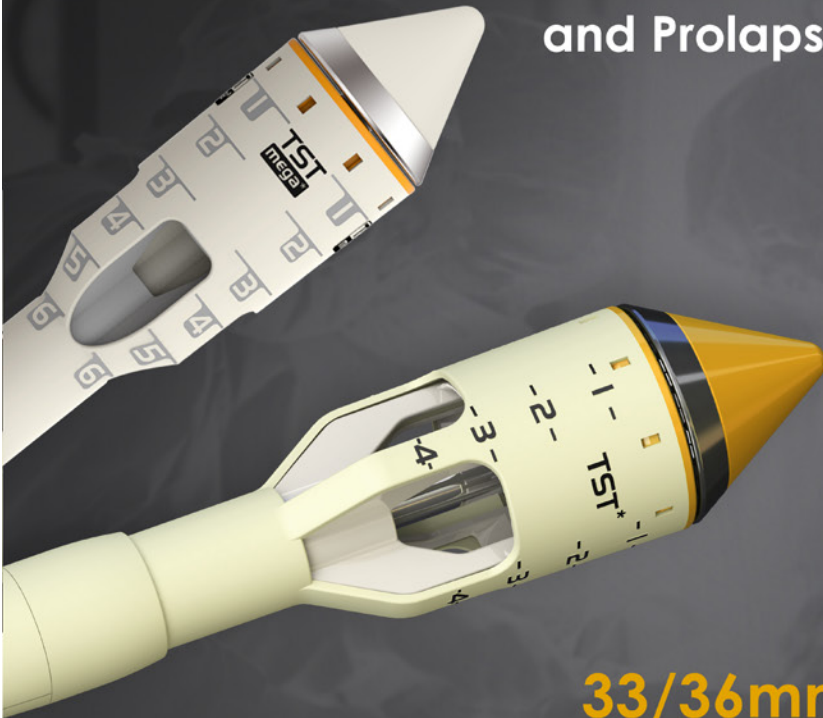

33/36mm

TOUCHSTONE

FELC
Bendos™

Endoscopic Linear Cutter
and Single Use Loading Unit

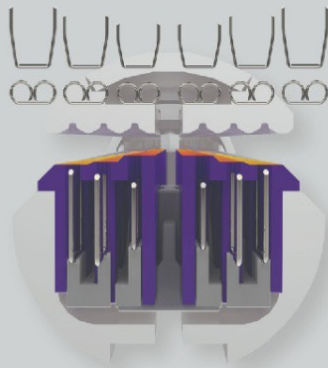

The 2nd Generation of Different Staple height

PROGRAM AT A GLANCE

24-25 OCTOBER

IFSOMINA Post Graduate Course	Ain Shams University Eldemerdash Hospital
--	--

THURSDAY

10:00-12:30	Session 1
12:30-01:00	Coffee Break
01:00-03:00	Session 2 (PASBMS Session)
03:00-03:30	Lunch break and symposium
03:30-06:30	Session 3
07:00 -08:00	Dinner

FRIDAY

10:00-12:00	Session 1 (Goss session)
10:00-10:15	Key note lecture
10:15-12:00	Goss Session
12:00-01:00	Friday Prayers and Coffee Break
01:00-03:00	Session 2 (Young IFSO Session)
03:00-03:30	Lunch Break and Symposium
03:30-06:30	Session 3
08:00-10:30	Gala Dinner

PROGRAM AT A GLANCE

SATURDAY

10:00-12:00	Session 1 (IFSO MENA Session)
12:00-12:30	Coffee Break
12:30-03:00	Session 2
03:00-03:30	Lunch Break
03:30-06:30	Session 3
07:00 -08:00	Dinner



ENDORSED CONGRESS



The International Federation for
the Surgery of Obesity and
Metabolic disorders (IFSO)

ESBS

**19th ANNUAL CONFERENCE OF
THE EGYPTIAN SOCIETY FOR
BARIATRIC SURGERY**

THE SECOND IFSOMENA POSTGRADUATE COURSE

in Collaboration with Ain Shams University Department of General Surgery
and the Egyptian Society for Bariatric Surgery

 **October 24-25, 2023**

 **Conference Center Al Demerdash University Hospital**

Mohey El Banna

Head of the Department of General Surgery,
Ain Shams Faculty of Medicine

Ahmed Ibrahim

Chief of Bariatric Surgery
Ain Shams Faculty of Medicine

Khaled Gawdat

President IFSO MENA Chapter

Ashraf Haddad

Chair of IFSO MENA Scientific committee

Alaa Abbas

Chair of IFSO MENA Educational Committee

Ahmed Osman

Course clinical coordinator
Ain Shams Faculty of medicine

DAY 1:

Sponsored By



08:45 -09:00

Registration

09:00- 11:45

Morning Session (OR Live Cases)

Sleeve Gastrectomy

Prof. Osama Fouad

Roux-En-Y gastric bypass

Prof. Ahmed Ibrahim

Revisional bariatric procedure or SADIs

Prof. Alaa Abbass

11:45-12:00

Coffee Break

12:00-03:00

Bariatric and Metabolic Surgery: Indications, Contraindications, and Selection

Prof. Mohey Elbanna

SLEEVE GASTRECTOMY over view and technical aspects

Prof. Khaled Gawdat

RYGB: Technical Aspects, tips and tricks of hand sewn anastomosis

Prof. Ashraf Haddad

OAGB/MGB: Technical Aspects

Prof. Osama Fouad

SADIs: Technical aspects

Prof. Alaa Abbas

Nutritional deficiencies after MBS prevention and management

Prof. Randa Abdelwahab

03:00- 03:30

Lunch

Sponsored By



DAY 2:

08:45 -09:00

Morning session (OR Cases)

09:00- 11:45

OAGB

Prof. Mohamed Abuzaid

SASI

Prof. Mohey Elbanna

Revisional bariatric Surgery

Prof. Khaled Gawdat

11:45-12:00

Coffee Break

12:00-03:00

Management of Bariatric surgery weight regain

Prof. Khaled Gawdat

Protein energy malnutrition after bariatric surgery: optimization protocol before revisional surgery

Prof. Asheaf Haddad

Bariatric leak management

Prof. Alaa Abbass

Bariatric hypoglycemia management

Prof. Randa Mabrouk

GERD after Sleeve Gastrectomy, What to do?

Prof. Mohey Elbanna

IFSO Statement: Ethics in bariatric surgery and alternative bariatric procedures Established and experimental procedures

Prof. Ashraf Haddad

For More Information and registration please contact:

Mr. Mohammed Gamal

01011777816

THURSDAY

10:00-12:30	Session 1 (10 minutes presentation 2 minutes discussion)	
Chairmen Faheem El Bassiony, Mohey El Banna, Bader Elhadrami, Moataz Basha, Saeed AlKayal		
10:00-10:15	Key Note lecture: Bariatric surgery between science and deception	Faheem El Bassiony
10:15-10:25	Implementation of AI technology in the enhancement of bariatric surgery outcomes	Mourad Niazi
10:25-10:35	Weight loss failure and regain after LAGB	Saeed AlKayal
10:35- 10:45	Sleeve Dor Fundoplication	Abdelrahman Salem
10:45-10:55	Single anastomosis sleeve jejunal bypass. A new promising bariatric procedure	Mohey ElBanna
10:55-11:05	New Concept in Bariatric surgery	Abduh El Banna
11:05-11:15	Reversal of gastric bypass	Moataz Basha
11:15-11:25	Outcome of distal one anastomosis gastric bypass with 300 cm common limb in primary versus revisional cases : A comparative Non randomized retrospective study	Hossam ElGhadban
11:25-11:35	Naturally banded sleeve gastrectomy (Sewefy wrap) vs non banded sleeve gastrectomy	Alaa Al-Sewefy
11:35-11:45	Laparoscopic sleeve gastrectomy with or without hiatal hernia repair: effect on gastroesophageal reflux disease in morbidly obese patients	Mohamed Matar
11:55-12:30	Discussion	
12:30-01:00	Coffee Break	

THURSDAY

01:00-3:00	Session 2 (PASMBS Session) (10 minutes presentation 2 minutes discussion)	
01:00-01:30	Medical therapy in Bariatric surgery	Sponsored by  Khaled Gawdat
Chair Dr Ahmad Bashir	Co-Chairs Mohamed Sharshar, Osama Taha, Alaa Abbass, Haytham Fawal	
01:30-01:40	Reversions after endoscopic sleeve gastroplasty	Aayed Al Qahtani
01:40-01:50	Conversion of OAGB to RYGB, dismantling vs Braun anastomosis	Osama Taha
01:50-02:00	OAGB with malnutrition and liver failure to RYGB complicated by leak	Alaa Wafa
02:00-02:10	OAGB In Adolescents	Hayssam Fawal
02:10-02:20	Portal Vein thrombosis post MBS	Mohamed Haddad
02:20-02:30	Malnutrition after SASI	Alaa Abbass
02:30-02:40	The Gastric Clip- Initial GBMC experience	Ahmed Bashir
02:40-03:00	Discussion	

03:00-03:30	Lunch break and symposium Bariatric surgery registry. How to control the data quality?	Sponsored by  Bart Torensma
--------------------	---	--

THURSDAY

03:30-06:30	Session 3 (10 minutes presentation 2 minutes discussion)	
Chairmen AbdelRahman Salem, Khaled Katri, Mohamed Diaa Sarhan, Hayssam Fawal, Ahmed Osman		
03:30 -03:40	Reflux after RYGB	Mustafa Ghurah
03:40-03:50	Catastrophic videos in Bariatric Surgery	Huneida Hamze
03:50-04:00	Unexpected event 10 years after laparoscopic gastric plication	Mohamed Sharaan
04:00-04:10	Laparoscopic one anastomosis gastric bypass after open vertical banded gastroplasty	Tamer Elmahdy
04:10-04:20	Outcome of revisional surgery for atypical bariatric operation	Hossam El Ghaban
04:20-04:30	Ergonomics in bariatric surgery	Mohamed Hamdy
04:30-04:40	The Dark side of bariatric surgery when everything goes wrong	Mohamed Diaa Sarhan
04:40-04:50	Banded OAGB	Osama Taha
04:50-05:00	Jujonojejonostomy An Achilles heal of roux-en-y gastric bypass construction	Khaled Katri
05:00-05:10	3 rd time operation: revisional roux-en-y gastric bypass post gastric band then open nissen fundoplication: difficulties and outcome	Mohamed Ammar
05:10-05:20	The controversial role of stent use in the management of leak post revisional bariatric surgery	Mohamed Hany Ashour
05:20-05:30	What to do in acute OAGB leak	Karim Sabry

THURSDAY

03:30-06:30	Session 3 (10 minutes presentation 2 minutes discussion)	
05:30-05:40	Revision after failed sleeve gastrectomy	Abdelrahman Salem
05:40-05:50	Internal hernia after revisional LRYGB for complicated open vbg	Ahmed Talha
05:50-06:00	BMI and Pre-operative medications as a predictive values for DM remission after Bariatric Surgery	Mahmoud Abdelaal
06:00-06:10	Imtraoperative celiac trunk bleeding during bariatric surgery	Mustafa Ghurah
06:10-06:20	Clinical imaging guidelines in bariatric surgery	Hany Hafez
06:20-06:30	Stubborn bleeding post MGB	Ali Khammas
07:00-08:00	Dinner (Main Restaurant)	

FRIDAY

10:00-10:15	Session 1 (Goss Session)	
10:00-10:15	Key Note Lecture Mechanism of Bile reflux after OAGB	Ali Al-Hamadani
10:15-11:45	Goss Session	
10:00-10:15	Chairmen Aayed Qahtani (GOSS President)	
10:00-10:15	Moderators Amer Al-Derazi, Khaled Al Amri, Mubarak AlKandary Ambulatory Bariatric surgery (ABS) (10 min)	
10:15-10:25	Definitions, Benefits, setup and current status of ABS world-wide	Aayed Al Qahtani
10:25-10:35	Standards of care and guidelines for ABS practice	Osama AlSaneaa
10:35- 10:45	Enhanced recovery ERAS in bariatric surgery	Medhat Shalaby
10:45-10:55	LSG as ABS procedure	Esaam Battayah
10:55-11:05	Bypass as ABS procedure	Aayed Alqahtani
11:05-11:15	Does paravertebral block help in doing ambulatory Bariatric surgery	Hayssam Fawal
11:15-12:00	Panel Discussion: Ali Khammas, Bader AlHadrami, Hend AlMajrafi, Mohamed AlJarallah, Moataz Basha	
12:00-01:00	Friday prayers and Coffee Break	

01:00-3:00	Session 2 (Young IFSO MENA Chapter Session)	
Chairmen Prof. Khaled Gawdat, Prof. Said Elkayal, Prof. Tamer Abdelbaki, Prof. Wah Yang		
Online Panelists: Sylvia Wiener, Sonja Chiappetta, Roxana Zakeri, Moritz Felsenreich, Shahab Shahabi, Jose Flores, Daniel Gero, Eren Halit.		
Opening speech	Tamer Abdelbaki Alexandria University	
Keynote lecture: How I build a revisional bariatric surgery center	Prof Bruno Dillemans	
Herniated Sleeve Gastrectomy With Weight Regain; Options to Revise	Mohamed Sharshar	
Transitioning to All Robotic Bariatric Practice From Laparoscopy	Toghrol Talishinskiy	
Challenges in Revision Surgery (video presentation)	Mostafa Gamal	
Surprises During Bariatric Surgery	Mohamed Diaa Sarhan	
LONG-TERM RESULTS AFTER BARIATRIC PROCEDURES. WHAT WE KNOW ABOUT FUTURE?	Aleksandr Neimark	
Video of Laparoscopic Roux en y Fistulojejunostomy for chronic gastric leak	Panagiotis Lanais	
The Devil in Redo after Gastroplication	Abdullellah Niyaz	
Bariatric Emergencies In A Non-Bariatric Centre: Feasibility and Literature Review	Mohanad Ibrahim	
03:00-03:30	Lunch break and symposium Bariatric Radiology Updates	Tamer Othman

03:30-06:30	Session 3 (10 minutes presentation 2 minutes discussion)	
Chairmen Ali Khammas, Mounir Ben Chatouh, Osama Taha , Mostafa Gamal, Osama Fouad		
03:30-03:45	Endoscopy in the bariatric field: a friend not a foe	Hany Shehab
03:45-04:00	Weight regain after Sleeve (Re-Sleeve vs Revisional OAGB) a comparative study	Osama Taha
04:00-04:10	Algorithm for the Post-bariatric Body Contouring	Awny Asklany
04:10-04:20	Revision of axially rotated sleeve with colon, pancreatic connection to RYGB	Emad Abdallah
04:20-04:30	Gastric leak after adjustable band removal	Ibrahim galal
04:30-04:40	Banded OAGB How I do it and personal indications	Mounir Ben Chatouh
04:40-04:50	OAGB as revisional procedure after failed primary sleeve gastrectomy	Yaser Aamer
04:50-05:00	Accidental lesion during sleeve gastrectomy, an interesting pathology	Ahmed AboKhozima
05:00-05:10	When bariatric surgery become an ongoing nightmare: post SG complicated case	Haitham ElMaleh
05:10-05:20	Roux-en-Y bypass as conversion procedure of failed gastric banding: short-term outcomes of 1295 patients in one single center	Ayman Mandour
05:20-05:30	Intraoperative endoscopy saves the day	Ashraf ElAttar
05:30-05:40	Revision of a revisional SADi s: challenges of the third revision	Ayman Soliman
05:40-06:30	Discussion	
07:30-10:30	Gala Dinner (Dusit Hall)	

10:00-12:00	Session 1 (IFSO MENA Session)	
Chair Dr Khaled Gawdat	Co-Chairs Mohamad Hadad, Hayssam Fawal	
A single Center experience of revising SASI for malnutrition. Why we started then we stopped!		Alaa wafa
VBG to OAGB: Why we should be outside old pouch?		Dr.Mohamad Abou Zaid
This outcome of Multiple revisional bariatric techniques: real world data		Dr.Aayed Al Qahtani
Revisional bypass insitus inversus totalis patient		Mohamed Diaa Sarhan
Proximal gastric bypass as a single maneuver in management of hiatus hernia/GERD in bariatric patients?		Ashraf El Attar
SASI to RYGB operative challenges		Karim Sabry
12:00-12:30	Coffee Break	

12:30-03:00	Session 2 (10 minutes presentation 2 minutes discussion)	
Chairmen Mustafa Ghurah, Ahmed Ibrahim, Sherif Hakky, Hassan Shaker, Ashraf Alattar		
12:30-12:40	Leakage after bariatric surgery: combined endo laparoscopic approach	Ahmed Ibrahim
12:40-12:50	Bariatric surgery in low BMI to control T2DM: what is the evidence?	Saeed Ali Alsareii
12:50-01:00	Interactable pain post gastric bypass. A diagnostic laparoscopy to decipher the anatomy	Sherif Hakky
01:00-01:10	persistent vomiting 3 months after MGB: case scenario and management	Mohamed El Emawy
01:10-01:20	Petersons space closure in OAGB	Mohamed Abu Zaid
01:20-01:30	Revisional bariatric surgery: Did we open a Pandora box?	Mohamed ElKseer
01:30-01:40	Unpredictable mal nutrition and short term outcomes after SASI	Ayman Kamal
01:40-01:50	OAGB Revisions, Undo or Conversion to RYGBP	Osama Taha
01:50-02:00	Incidentally discovered gastric lesions During Bariatric procedures	Ahmed Abo ElMagd
02:00-02:10	Total small bowel length measurement	Karim Sabry
02:10-02:20	Tirzepatide as a new era for weight loss citis worth?	Osama Taha
02:20-03:00	Discussion	

03:00-03:30	Lunch Symposium and Break	Sponsored by 	Osama Taha
--------------------	----------------------------------	---	------------

03:30-06:30	Session 3	
Chairmen Mohamed Hany Ashour, Abdel Aziz Tallab, Haytham Almaleh, Mohamed Abuzeid, Kareem Sabry		
03:30-03:40	Roux en Y gastric bypass with cruroplasty as revisional procedure for twisted sleeve with hiatal hernia	Bassem Hegazy
03:40-03:50	OAGB for obese patient with hiatal hernia and large paraoesophageal lipoma	Ahmed Hammad
03:50-04:00	Management of gastric neuroendocrine tumor by sleeve bipartition in a morbidly obese patient	Mohamed Mokhtar
04:00-04:10	Early post sleeve gastrectomy bleeding: is there any change?	Abd-ElFatah Kalmoush
04:10-04:20	lessons learned from the first 75 banded laparoscopic sleeve gastrectomies: why I removed bands?	Hossam ElGhadban
04:20-04:30	Accidental Stapling the Oro-gastric tube	Mahmoud Abdelaal
04:30-04:40	Uncommon site of leakage post reinforced sleeve gastrectomy. How to manage	Mohamed Elmanakhly
04:40-04:50	Revised SASI to sleeve with hiatal repair for excessive weight loss	Mohamed Mosaad
04:50-05:00	Complications caused by a Rogue barbed suture	Mohamed Hany Ashour

SATURDAY

03:30-06:30	Session 3	
05:00-05:10	Laparoscopic reversal of OAGB for excessive weight loss	Ahmed Talha
05:10-05:20	Challenges during bariatric procedures: to abort or not to abort	Mohamed Matar
05:20-05:30	Management of complicated banded RYGB	Osama Taha
05:30-05:40	Intraoperative complications during re recurrent hiatal hernia post LRYGB	Ayman Soliman
05:40-05:50	Weight loss failure after SG: outcomes of conversion to MGB.	Mohamed Elemawy
05:50-06:00	Bariatric surgery in patients with liver cirrhosis	Yaser Aamer
06:00-06:30	Discussion	
06:30-07:30	Dinner (Main Restaurant)	

SPONSORSHIP:



FULBRIGHT
we think next

A NEW ERA OF ENDOSCOPIC SURGERY



RELIABLE **ECONOMICAL**

LIGHTER **DESIGNER**

POWER **SMARTER**



BOWA
M E D I C A L



LOTUS
The powerful torsional
ultrasonic scalpel

TOUCHSTONE

CSC
ECSC

Intraluminal Stapler
for Single Use

Rotating Blade System



XNY MEDICAL



SURGICAL STAPLERS

75
mm



60
mm



45
mm



ULTRA NOVA SURGICAL SYSTEM



PULL GREEN TRIGGER
RETURN JAW

EZISURG MEDICAL

EASYENDO™ SERIES LITE



120° Active Articulation

Consistent Staple Formation

Ergonomic Design

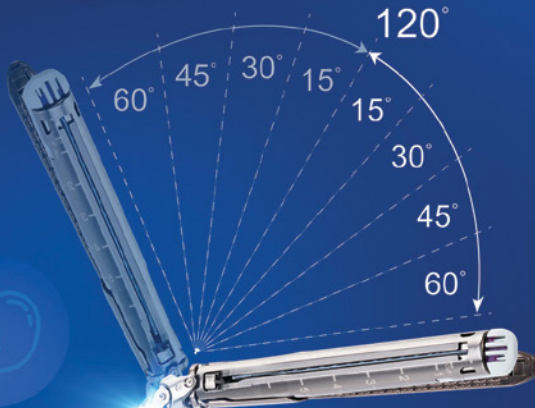

A 120° degree of articulation gives you the freedom to manipulate your stapler and position it where you prefer.



Arabian Co
medical equipment

MINIMIZER GASTRIC RING

In banded gastric bypass and banded gastric sleeve

- ✓ A non-adjustable gastric ring should be used
- ✓ It should be easy to place
- ✓ Have the correct size for that particular patient
- ✓ Should be visible on X-ray and be safe





Saxenda®
liraglutide 6mg/ml solution
for subcutaneous injection